

1 2 3 4 5 6 7 8 9 10 11 12 13 14

A  
B  
C  
D  
E

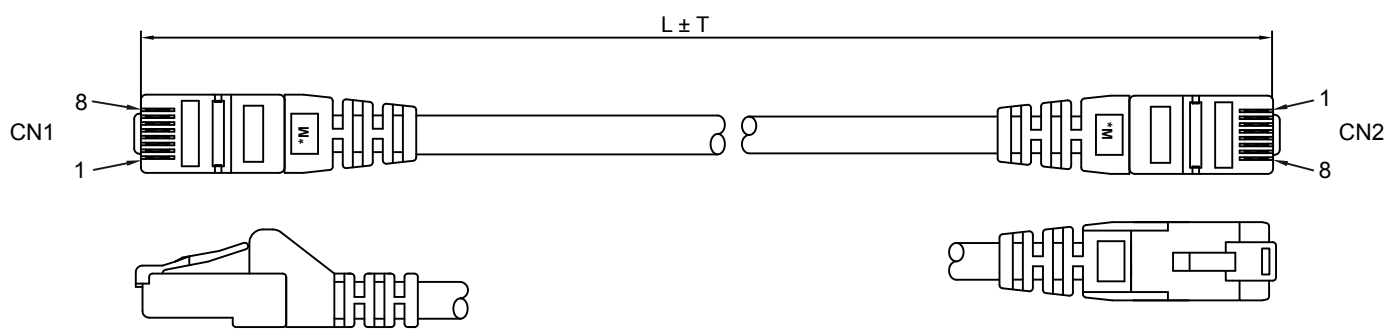

**PIN OUT**

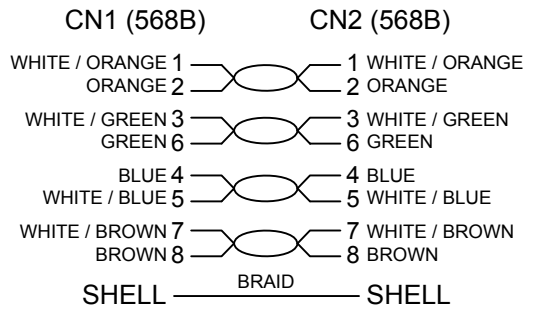

|                                                                 |                                                                 |
|-----------------------------------------------------------------|-----------------------------------------------------------------|
| Spezifikation / Specification                                   | CAT 6                                                           |
| Kabeltyp / Cable type                                           | Rundkabel / round cable                                         |
| Innenleiter, Material / Inner conductor material                | CCA (kupferkaschiertes Aluminium) / CCA (copper-clad aluminium) |
| Innenleiter, Aderdurchmesser / Inner conductor, core diameter   | (7/0.135 ± 0.005 mm)                                            |
| AWG                                                             | 27/7 (stranded)                                                 |
| Schirmungsklasse / Shielding class                              | S/FTP (PiMF)                                                    |
| Anzahl Schirmungen / Number of shieldings                       | 2 x                                                             |
| Typ 1, Schirmung / Type 1, shielding                            | Folie (Alu) PiMF/ foil (alu) PiMF                               |
| Typ 2, Schirmung / Type 2, shielding                            | Geflecht (Alu) Gesamtschirm/ braid (alu) overall shield         |
| Durchmesser Kabelmantel (ca.) / Cable sheath diameter (approx.) | Ø 6.0 ± 0.2 mm, PVC                                             |
| Knickschutz / Kink protection                                   | beidseitig / both sides                                         |
| Anschluss, Typ / Connection, type                               | RJ45-Stecker (8P8C) / RJ45 male (8P8C)                          |
| Anschluss, Schirmung / Connection, shielding                    | ja / yes                                                        |
| Anschluss 2, Typ / Connection 2, type                           | RJ45-Stecker (8P8C) / RJ45 male (8P8C)                          |
| Rastnasenschutz / Latch protection                              | beidseitig / both sides                                         |
| max. Bandbreite / max. bandwidth                                | 250 MHz                                                         |

A  
B  
C  
D  
E

F  
G  
H



**CAT 6 Patchkabel, S/FTP (PiMF)**

- doppelt geschirmtes LAN/Netzwerkkabel zum Anschluss Ihrer Netzwerkkomponenten mit 2x RJ45 Steckern
- mit vergoldeten Kontaktflächen (PINs)
- Aderpaarschirmung: PIMF (Paare in Metall Folie) + Gesamtschirmung: Geflecht
- Längenangabe auf Slimline-Knickschutztülle
- mit Rastnasenschutz
- Paarfolge nach EIA/TIA 568B
- Gigabit (10/100/1000 Mbit) Netzwerk geeignet

**CAT 6 patch cable S/FTP (PiMF)**

- double shielded LAN/network cable to connect network components with 2 x RJ45 connectors
- with gold plated PINs
- pairs screening: PIMF (pairs in metal foil) + outer shield: braiding
- with length indication on the slimline strain relief
- with latch protection
- pair-sequence acc. to EIA/TIA 568B
- suitable for Gigabit (10/100/1000 Mbit)

F  
G  
H

I  
J











|                                            |      |        |      |                                    |                 |
|--------------------------------------------|------|--------|------|------------------------------------|-----------------|
| <b>Änderungen</b>                          |      | Datum  | Name | Bezeichnung                        | Blatt           |
| Datum                                      | Name | gez.:  | sm   | CAT 6-xxxx S/FTP PIMF LC<br>x.xx m |                 |
|                                            |      | gepr.: | ac   |                                    | Zeichnungs-Nr.: |
|                                            |      | Norm:  |      | 93371ff                            |                 |
| Änderungen vorbehalten / Subject to change |      |        |      |                                    |                 |



1 2 3 4 5 6 7 8 9 10 11 12 13 14

|   |            |      |                                            |            |      |                          |   |   |                 |    |       |    |    |    |  |
|---|------------|------|--------------------------------------------|------------|------|--------------------------|---|---|-----------------|----|-------|----|----|----|--|
|   | 1          | 2    | 3                                          | 4          | 5    | 6                        | 7 | 8 | 9               | 10 | 11    | 12 | 13 | 14 |  |
| A |            |      |                                            |            |      |                          |   |   |                 |    |       |    |    |    |  |
| B |            |      |                                            |            |      |                          |   |   |                 |    |       |    |    |    |  |
| C |            |      |                                            |            |      |                          |   |   |                 |    |       |    |    |    |  |
| D |            |      |                                            |            |      |                          |   |   |                 |    |       |    |    |    |  |
| E |            |      |                                            |            |      |                          |   |   |                 |    |       |    |    |    |  |
| F |            |      |                                            |            |      |                          |   |   |                 |    |       |    |    |    |  |
| G |            |      |                                            |            |      |                          |   |   |                 |    |       |    |    |    |  |
| H |            |      |                                            |            |      |                          |   |   |                 |    |       |    |    |    |  |
| I | Änderungen |      |                                            | Datum      | Name | Bezeichnung              |   |   |                 |    | Blatt |    |    |    |  |
| J | Datum      | Name | gez.:                                      | 27.08.2020 | sm   | CAT 6-xxxx S/FTP PIMF LC |   |   |                 |    | 2 / 2 |    |    |    |  |
|   |            |      | gepr.:                                     | 27.08.2020 | ac   | x.xx m                   |   |   |                 |    | von   |    |    |    |  |
|   |            |      | Norm:                                      |            |      |                          |   |   | Zeichnungs-Nr.: |    |       |    |    |    |  |
|   |            |      | Änderungen vorbehalten / Subject to change |            |      | 93371ff                  |   |   |                 |    |       |    |    |    |  |
|   | 1          | 2    | 3                                          | 4          | 5    | 6                        | 7 | 8 | 9               | 10 | 11    | 12 | 13 | 14 |  |

| Farbe / Colour                                                                                    | Art.  | L [m] | Farbe / Colour                                                                                 | Art.  | L [m] | Farbe / Colour                                                                                   | Art.  | L [m] | Farbe / Colour                                                                                      | Art.  | L [m] | Farbe / Colour                                                                                        | Art.  | L [m] |
|---------------------------------------------------------------------------------------------------|-------|-------|------------------------------------------------------------------------------------------------|-------|-------|--------------------------------------------------------------------------------------------------|-------|-------|-----------------------------------------------------------------------------------------------------|-------|-------|-------------------------------------------------------------------------------------------------------|-------|-------|
|  schwarz / black | 95458 | 0.25  |  grau / grey  | 93371 | 0.25  |  weiß / white  | 95461 | 0.25  |  orange / orange | 95456 | 0.25  |  violett / violett | 95460 | 0.25  |
|                                                                                                   | 95468 | 0.50  |                                                                                                | 93568 | 0.50  |                                                                                                  | 95471 | 0.50  |                                                                                                     | 95466 | 0.50  |                                                                                                       | 95470 | 0.50  |
|                                                                                                   | 95478 | 1.00  |                                                                                                | 93569 | 1.00  |                                                                                                  | 95481 | 1.00  |                                                                                                     | 95476 | 1.00  |                                                                                                       | 95480 | 1.00  |
|                                                                                                   | 95572 | 1.50  |                                                                                                | 95567 | 1.50  |                                                                                                  | 95575 | 1.50  |                                                                                                     | 95570 | 1.50  |                                                                                                       | 95574 | 1.50  |
|                                                                                                   | 95498 | 2.00  |                                                                                                | 93570 | 2.00  |                                                                                                  | 95501 | 2.00  |                                                                                                     | 95496 | 2.00  |                                                                                                       | 95500 | 2.00  |
|                                                                                                   | 95508 | 3.00  |                                                                                                | 93571 | 3.00  |                                                                                                  | 95511 | 3.00  |                                                                                                     | 95506 | 3.00  |                                                                                                       | 95510 | 3.00  |
|                                                                                                   | 95518 | 5.00  |                                                                                                | 93572 | 5.00  |                                                                                                  | 95521 | 5.00  |                                                                                                     | 95516 | 5.00  |                                                                                                       | 95520 | 5.00  |
|                                                                                                   | 95528 | 7.50  |                                                                                                | 93650 | 7.50  |                                                                                                  | 95531 | 7.50  |                                                                                                     | 95526 | 7.50  |                                                                                                       | 95530 | 7.50  |
|                                                                                                   | 95488 | 10.00 |                                                                                                | 93651 | 10.00 |                                                                                                  | 95491 | 10.00 |                                                                                                     | 95486 | 10.00 |                                                                                                       | 95490 | 10.00 |
|  blau / blue     | 95452 | 0.25  |  grün / green | 95454 | 0.25  |  gelb / yellow | 95453 | 0.25  |  rot / red       | 95457 | 0.25  |  magenta / magenta | 95455 | 0.25  |
|                                                                                                   | 95462 | 0.50  |                                                                                                | 95464 | 0.50  |                                                                                                  | 95463 | 0.50  |                                                                                                     | 95467 | 0.50  |                                                                                                       | 95465 | 0.50  |
|                                                                                                   | 95472 | 1.00  |                                                                                                | 95474 | 1.00  |                                                                                                  | 95473 | 1.00  |                                                                                                     | 95477 | 1.00  |                                                                                                       | 95475 | 1.00  |
|                                                                                                   | 95565 | 1.50  |                                                                                                | 95568 | 1.50  |                                                                                                  | 95566 | 1.50  |                                                                                                     | 95571 | 1.50  |                                                                                                       | 95569 | 1.50  |
|                                                                                                   | 95492 | 2.00  |                                                                                                | 95494 | 2.00  |                                                                                                  | 95493 | 2.00  |                                                                                                     | 95497 | 2.00  |                                                                                                       | 95495 | 2.00  |
|                                                                                                   | 95502 | 3.00  |                                                                                                | 95504 | 3.00  |                                                                                                  | 95503 | 3.00  |                                                                                                     | 95507 | 3.00  |                                                                                                       | 95505 | 3.00  |
|                                                                                                   | 95512 | 5.00  |                                                                                                | 95514 | 5.00  |                                                                                                  | 95513 | 5.00  |                                                                                                     | 95517 | 5.00  |                                                                                                       | 95515 | 5.00  |
|                                                                                                   | 95522 | 7.50  |                                                                                                | 95524 | 7.50  |                                                                                                  | 95523 | 7.50  |                                                                                                     | 95527 | 7.50  |                                                                                                       | 95525 | 7.50  |
|                                                                                                   | 95482 | 10.00 |                                                                                                | 95484 | 10.00 |                                                                                                  | 95483 | 10.00 |                                                                                                     | 95487 | 10.00 |                                                                                                       |       |       |